

Induction Power Supplies

25KW; 135 – 400 KHz

LCD Display
(Integral Heat Station)

User's Guide



Model 25-135/400-4

05/08
Rev D

1. Specifications and features.....	3
2. Getting started.....	6
3. Connections	8
4. Front panel description and operation.....	10
5. Programming and Status monitor	16
6. Load station tuning.....	22
7. APPENDIX A: USER INTERFACE.....	25
8. Layout.....	27
9. Finding dew point.....	28

1. Specifications and features

1.1. Output

Maximum Power	25kW ¹
Maximum Apparent Power	50kVA @ 240V input
Minimum Power Factor	0.5 @ 240 input
Duty Cycle	100%
Maximum Voltage	500V ²
Power Transformers (6)	2 :1
Frequency Range	135kHz to 400kHz
Capacitor current carrying capability	3200 Amps
Maximum response time	0.1s ³
Minimum Allowed OFF-Time	0.5s

1.2. Input

AC line-to-line voltage	240V ± 10%, 3 ϕ , 50 to 60Hz
AC line current	70A @ 240V
AC power	29kVA

1.3. Physical

Dimensions: Depth	16in (41cm)
Width	20in (51cm)
Height	43.75in (111cm)
Weight	275lb (125kg) approximately

¹ Inverter output power i.e. includes power losses in heat station.

² Mainly limited by the rating of resonant capacitors. Consult manufacturer for operating at output voltages above 500V rms.

³ When using the adjustable start-frequency feature.

1.4. Front panel controls and indicators

LED Indicators	Yellow indicator for limit. Red indicators for fault and trip. Red indicator for fault. Yellow and Green indicators for heat on and off.
Numeric Displays	Run time read-outs for: Job and Step for Programmed mode Elapsed time for heat period power meter (0-100%)
LCD Display	Working mode and Messages for fault, trip and limit Run time read-outs for: Power demand, operating frequency, capacitor voltage and inverter current
Controls – Switch and knob	Push button switch for Heat ON/OFF. Single turn knob for power level. (Manual mode) Pushbutton to reset trips. Emergency stop button.
Program keys	21 keys for Program and monitoring command

1.5. Internal heat station

Resonant capacitors	Mounting space provided for sixteen capacitors. Twelve 210nF, 500V or 8 200nF, 700V capacitors supplied. 330nf available
Series Parallel Capacitor Rail	Kit available (optional)
Series inductor	Adjustable for load matching

1.6. Protection

Power	Limited to 25kW in any feedback configuration
Inverter output current	Limited to 500A peak. Short circuit protected.
Resonant capacitor voltage	Limited to 500V rms
Line current	100A Circuit breaker
DC link current	150A Semiconductor fuse
Temperature and cooling water	Temperature switch on inlet water. Differential pressure switch between water inlet and outlet.
Safety Interlocks	Emergency stop button or door switch opens the main circuit breaker.

1.7. Load

Quality factor of load	Will operate with any load Q (including resistive loads), provided that the output frequency and voltage is within the specifications.
Connection	Selectable between left and right. Custom output connection provided.

1.8. Cooling water

Maximum pressure	100PSI (690kPa)
Minimum differential pressure	30PSI (207kPa)
Minimum water flow	3.5GPM (0.283l/s)
Maximum inlet water temperature	110°F (43.3°C)
Minimum inlet water temperature	Approx. 90° F (32°C)**
Minimum water resistivity	590Ω.in (1500Ω.cm)
Supply hose location	Selectable between left or right

** must be set above dew point (see page 29)

2. Getting started

2.1. Safety Warnings

HIGH FREQUENCY RADIATION can interfere with radio navigation, safety services, computers and communication equipment.

Have only qualified person familiar with electronic equipment perform this installation.

The user is responsible for having a qualified electrician promptly correct any interference problem resulting from the installation.

Any modifications performed on this power supply may void warranty. Contact manufacturer for approval before any modifications are performed.

Have the installation regularly checked and maintained.
Keep high-frequency source door and panels tightly shut.

1. Read this operation manual completely before using the power supply.
2. **Induction heating can be dangerous.** Obey all warnings on unit and in manual.
3. **Do not touch live electrical parts.** In operation, this means the output connectors, the work coil, the work piece, and any bus work or cabling connecting them.

	<p>WARNING: These symbols, placed at the outputs of the power supply, warn of the electric shock hazard there and RF burn hazard at the outputs when the unit is operating.</p>
---	--

	<p><u>Disconnect input power before installing or servicing this unit.</u> The input AC voltage is live at the top of the main circuit breaker and the control power circuit breaker. The door interlock will prevent the main breaker from being closed when the door is opened, but the control power breaker can be on and 240VAC can be live inside the cabinet.</p>
---	---

2.2. Set-up

The following is a list of steps describing the required actions to get the power supply set up.

1. Check for any visual damage that could have happened during shipment. Check all plug-in connectors on PCBs.

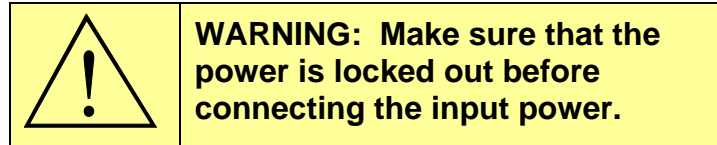

2. Ensure that both the circuit breakers, located on the door of the unit, are in the OFF position. Wire the power supply to the supply voltage as described in section 0
3. Connect the heating coil and load to the output of the unit (see section 4.).
4. Connect and test the cooling water supply, as described in section 0
5. Read section 0 to become familiar with the front panel controls.
6. Do initial setups of the internal heat station, as described in section 6.1.
7. Do the tuning of the heat station, as described in section 6.2 The power supply will not operate if the emergency stop button is pressed in or the door is not closed.
8. The unit is now ready for operation, and can be controlled by the front panel.
9. The unit is programmed for power control. For inverter current, load voltage or auxiliary control see section 5.1.

3. Connections

This section gives a description of the required steps to connect the supply voltage, load, cooling water and remote loader to the unit.

3

3.1 Three phase input voltage

	WARNING: Make sure that the power is locked out before connecting AC power to the unit. Connect only 220-240V, 3~.
---	---

A hole needs to be punched in the cabinet of the power supply for the supply voltage cable. It can be done in one of two recommended locations. The primary location (1) is on the left side of cabinet next to left blank cover. The second location (2) is at right side rear. Cut-outs in cabinets will be available and cover plates will be removable to make it easy for drilling holes for power cables.

(3) A third cutout is provided for control wiring.

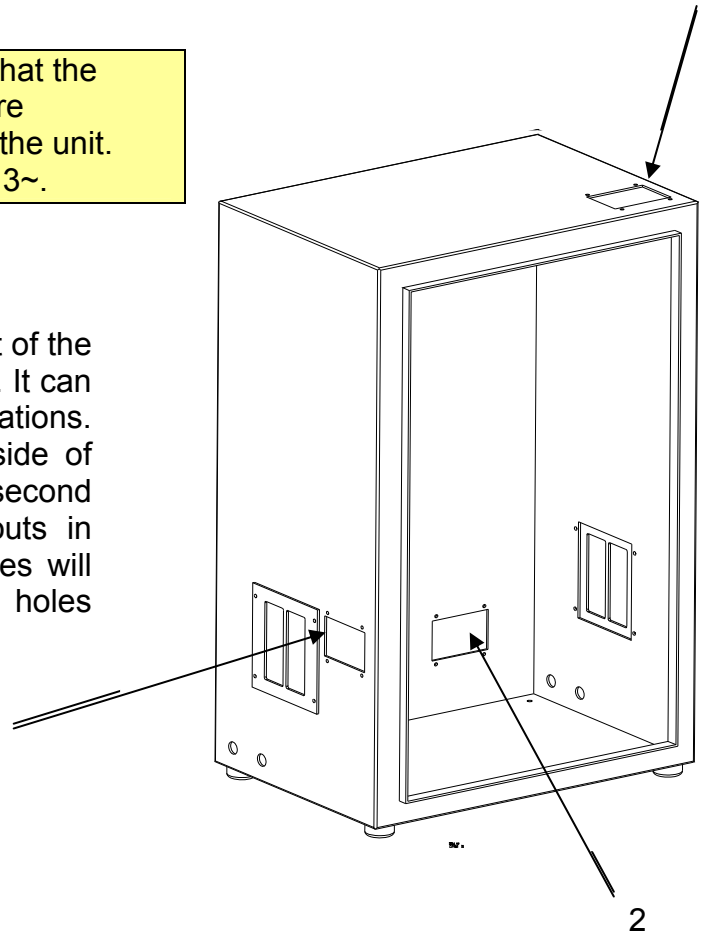

3.2 Load

The load can be connected to the left or right side of the power supply. The unit is shipped with the output on the right hand side. To change the output to the left hand side, exchange the copper output blocks and covers between the two sides. The load or cables connect to the output blocks. Ensure o-rings are used to avoid water leakage. See Figure 2.

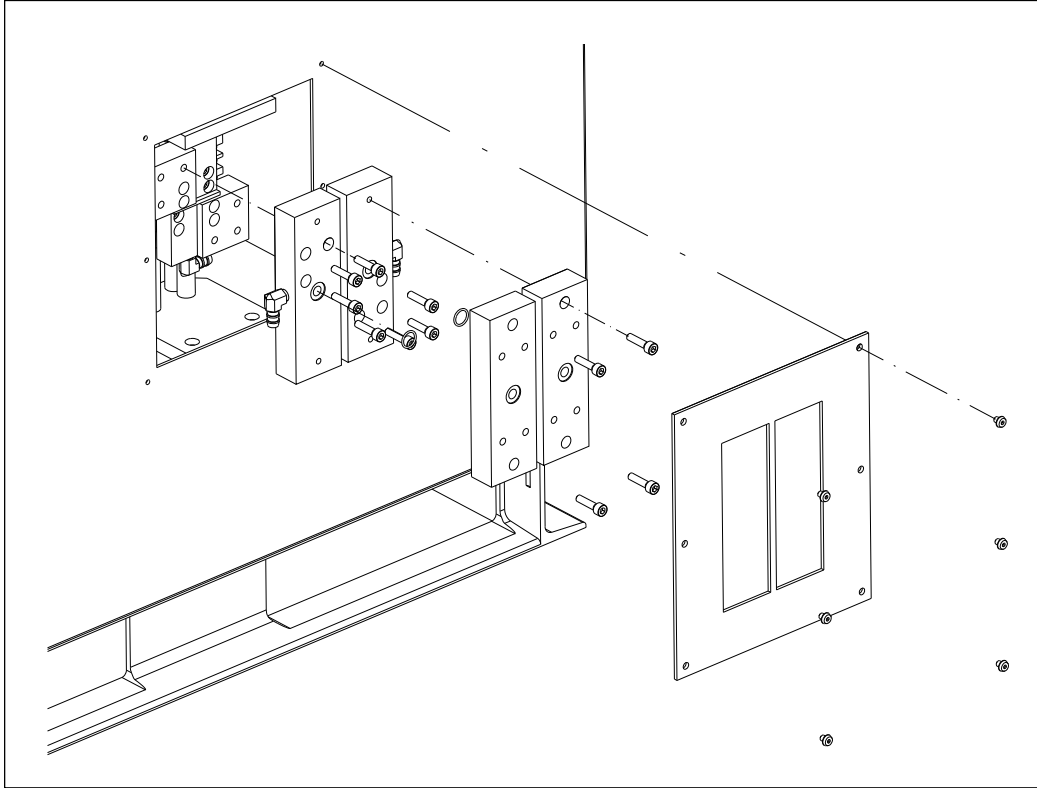

Figure 2: Output blocks mounting.

3.3 Cooling water

The cooling water can be connected to the left or right side of the power supply. The unit is shipped with the water inputs on the left hand side. Two female $\frac{1}{4}$ " NPT connections are provided. If required, move the water fittings to the right hand side. Keep the input towards the back of the unit and output towards the front of the unit location. The unit will not operate if the water flow is reversed.

Turn on the cooling water flow and verify that it meets the minimum requirements as given in section 1.8. on page 5. Check for any water leaks on the inlet, outlet and heating coil. Tighten connections if necessary. Also check for any water leaks inside the unit that could have been caused by shipping, and tighten any hose clamps if necessary.

4. Front panel description and operation

4.1 Front panel description

This section identifies and describes the various parts of the front panel.

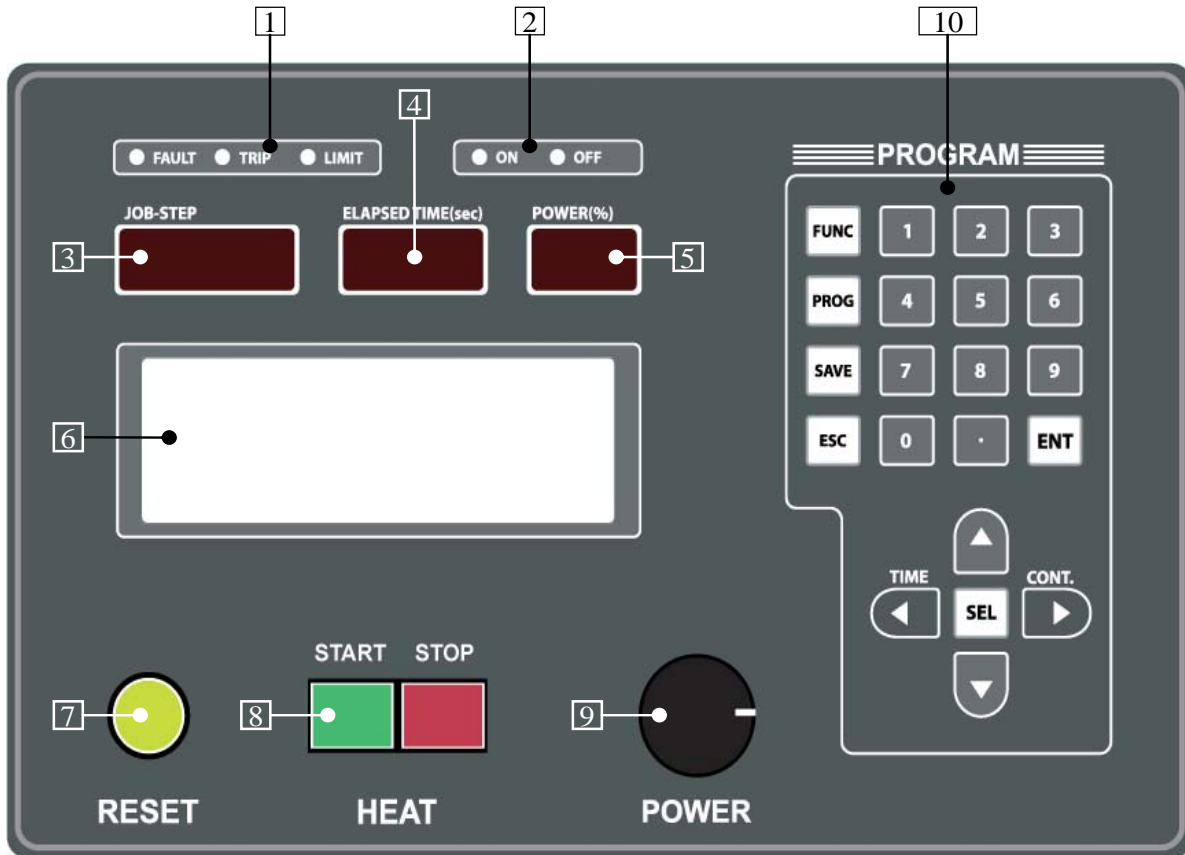

1) Fault, Trip and Limit LEDs	6) LCD display
2) Heat On/Off LEDs	7) Reset button
3) Program Indicator	8) Heat switch
4) Time Indicator	9) Power Knob
5) Power Indicator	10) Program Buttons

Figure 3: Front panel layout.

4.1.1 Fault, Trip and Limit indicators

Identified by ① --► in Figure 3.

Fault indicator: This indicator is red in color and is lit if the unit gets any faults. No power is being delivered to the load and the heat OFF indicator will be lit.

There are six fault statuses displayed on LCD:

- E-STOP: Indicates that the unit is in Emergency stop status.
- AUX INT: An auxiliary interlock wired to the unit has tripped it.
- DOOR OPEN: Indicates that the door of the unit is not closed.
- WATER PRESS: Indicates that there is inadequate differential water pressure.
- WATER TEMP: Indicates that the temperature of the inlet water has exceeded the allowable level. (see 5.2.)
- PARAMETER: Indicates that the wrong parameters have been set. (see 5.2.)

Trip indicator: This indicator is red in color and is lit when the unit has been tripped. No power is being delivered to the load and the heat OFF indicator will be lit.

There are three trip statuses displayed on LCD:

- SW/THRU TRIP: The inverter circuit failed or swing through signal missing due to a short in the load, heat station component or poor tuning of the heat station components.
- RES TRIP: The circuit momentarily operated below the resonant frequency due to e.g. a short in the load or heat station component or poor tuning of the heat station components.
- I.C TRIP: The inverter current momentarily exceeded the set maximum peak value due to e.g. a short in the load or heat station component or poor tuning of the heat station components.

Limit indicator: This indicator is yellow in color and is lit when the heat station is not properly tuned. The power output of the unit is limited below the desired level set by the power knob or remote input. There are four limit indicators:

- POWER LIMIT: If lit the power is being limited at 25kW.
- FRQ LIMIT: If lit the circuit is being limited at the resonant frequency of the resonant tank.
- C.V LIMIT: If lit the capacitor voltage is being limited at 500V or 700V rms.
- I.C LIMIT: If lit the inverter current is being limited at 500A peak. (Note: The load coil current could be much higher than 500A peak).

C.V, I.C and FRQ limit can occur simultaneously and those limit messages can be displayed together e.g. if C.V limit and FRQ limit occur at once “FRQ/C.V LIMIT” will display.

If any limit indicators are lit, the heat station components needs to be adjusted to obtain the required power (see section 6.2).

4.1.2. Heat ON/OFF indicators.

These LEDs show whether the power supply is generating output or is off. (identified by ② --► in Figure 3.).

4.1.3. Program status indicator.

Identified by ③ --► in Figure 3. This read-out displays the programs status when using the PROGRAMMED mode. Selected JOB profile number and STEP order will display as like “1-12”

4.1.4. Time display indicator.

Identified by ④ --► in Figure 3. This read-out displays elapsed heating time as seconds

4.1.5. Power display indicator

Identified by ⑤ --► in Figure 3. This read-out displays the power output when the power supply is operating.

4.1.6. LCD display

Identified by ⑥ --► in Figure 3. Details information display on LCD display.

MANUAL	[T=2.5S]	LOC
>> POWER LIMIT		
P.S=50%	C.V=500V	
I.C=320A	FRQ=370KHz	

Figure 4: LCD display layout.

1st line: Displays Control mode.

- **MANUAL [CONT]:** Indicates power supply working in manual continuous mode.
- **MANUAL [T=0.0S]:** Indicates power supply working in manual timed mode.
- **PROGRAMMED:** Indicates power supply working in programmed mode. Selected job number display on Program status indicator.
- **LOC:** Indicates Local control mode.
- **EXT:** Indicates External control mode.
- **REM:** Indicates Remote control mode.

2nd line: Alert status like fault, trip or limit. (See 4.1.1.)

3rd line: Indicates requested power level (manual mode) or number of heat cycles in auto repeat (programmed mode) and capacitor voltage.

- P.S: Percentage of requested power level.
- REP: Number of cycles in auto repeat.
- Operating frequency

4th line: Indicate capacitor voltage C.V: and inverter current I.C.

4.1.7. Reset button

Identified by ⑦ --► in Figure 3. This button is used to clear the fault and/or trip indicators if a run-time or interlock trip has occurred. Depressing the button will clear the latch for the fault and trip indicators. If the LED does not go out, then the reason for the fault is still present.

4.1.8. Heat switch

Identified by ⑧ --► Figure 3. When the power supply is energized, and no fault indicators are lit, pressing the START button will start the power supply delivering heat. When moved back to the STOP position, the heating will be terminated. While in PROGRAMMED mode, the ON position initiates the heat cycle. Pressing the STOP button will terminate the heat cycle.

4.1.9. Power Pot

Identified by ⑨ --► in Figure 3. The power pot sets the requested power level indicated as P.S on LCD display. The level of power output is indicated by the percentage on the POWER indicator LED. This pot is disabled during PROGRAMMED mode operation.

4.1.10. Program buttons

Identified by ⑩ --► in Figure 3. The program buttons are used to program and display jobs for the power supply to run automatically. See section 5 for a description of how to program the power supply.

4.2. Operation

4.2.1. Manual mode operation

Turn on the control breaker, and then LCD display shows as below. Operation mode and heat control mode displayed on the 1st line.

Select Manual mode in the programming if current mode is programmed. (see section 5.1.)

MANUAL	[CONT]	LOC
>> POWER LIMIT		
P.S=50%	C.V=500V	
I.C=300A	FRQ=370KHz	

MANUAL	[T=2.5S]	LOC
>> POWER LIMIT		
P.S=50%	C.V=500V	
I.C=300A	FRQ=370KHz	

There are two selections in Manual mode.

When Manual is in continuous mode: "MANUAL [CONT]" displays on 1st line of LCD,
When Manual is in timed mode: "MANUAL [T=0.0S] displays on 1st line of LCD.

1) Operation in Manual continuous mode.

Press START switch to heat on and press STOP switch to heat off.

If current mode is in manual timed, you can change the mode by pressing RIGHT (▶) key for 1 sec. or more to manual continuous mode.

2) Operation in Manual timed mode.

Press START switch to heat on and unit will stop after the set time has ended.

If current mode is manual continuous, you can change the mode by pressing LEFT (◀) key for 1 sec. or more to manual timed mode and the LCD [T=0.0S] will blink. You can enter the time you want to change with numeric keys and then press ENT key to save.

4.2.2. Programmed mode operation

Select Programmed mode in the programming if current mode is manual. (see section 5.1.)

PROGRAMMED	LOC
>> POWER LIMIT	
P.S=50%	C.V=500V
I.C=300A	FRQ=370KHz

Press START switch to start process, the unit follows the selected job profile and then stops.

See section 5.1., for programming job profile.

5. Programming & Status monitor

5.1. Programming

The power supply can be programmed to control the functions below through the menu.

1) Control mode :

- Operating mode
- Heat control mode
- External heat control
- External reset control
- External emergency stop

- Aux. interlock control
 - Power control mode
 - Feedback control mode
- 2) **Job select:** Selecting job to proceed under Programmed mode.
 - 3) **Job order:** Setting Job parameters in each profile.
 - 4) **System parameters:** Setting control parameters.
 - Power limit
 - Capacitor voltage limit
 - Inverter current limit
 - Shutdown water inlet temperature (Does not apply for 25kW)
 - Restart water inlet temperature (Does not apply for 25kW)
 - Communication address
 - Communication baud rate
 - Operating frequency range
 - Capacitor rail configuration
 - 5) **Start frequency:** Setting start frequency.
 - 6) **Pass word:** Changing password.

5.1.1. Entering a program

1. Turn on the power supply.
2. Enter the program mode by pressing the “PROG” button for 1 second, to display “password=” on LCD, enter password, and press “ENT” key to display “PROGRAM menu”. (Default password=0000)
3. Use UP (▲) and DOWN (▼) key to move object item to program and select the item with ‘ENT” or “SEL” key to enter into the item.
4. Press “ESC” key to exit program mode

5.1.2. Control mode

1. Select the item “CONTROL MODE” in PROGRAM menu.
2. Use UP (▲) and DOWN (▼) key to move object item to program and select the item.
3. Select each value with LEFT (◀) and RIGHT (▶) key and press “SAVE” key to save the new values and return to PROGRAM menu.
4. Press “ESC” key, to return to PROGRAM menu without saving the changed values

- **OPER MODE:** Setting operating mode.
 - MANUAL: Operate heat on/off or power level by switches or knob on the panel or external signal.
 - PROGRAMMED: Operate process by programmed job profile.
- **HEAT CONT:** Setting Heat control mode.
 - LOCAL: Heating on or off by START/STOP switch on the panel.
 - EXT: Heating on or off by external heat contact input connected to E- HEAT terminal of TB2 on EXT-TERM board.
 - REMOTE: Operate by control command from remote loader or PC.

- **EXT HEAT:** Selecting External heat control mode.
(only when unit is in “HEAT CONT = EXT” mode.
 - **MOMENT:** On or off by contact of E- HEAT terminal of TB2 on EXT-TERM board (close=On, open=Off)
 - **LATCH:** Latch On or latch off alternately by contact close triggering of E- HEAT terminal of TB2 on EXT-TERM board.
- **EXT RESET:** Selecting external reset function: enable or disable.
 - **DISABLE:**
 - **ENABLE:**
- **EXT E.STOP:** Selecting external emergency stop function: enable or disable.
 - **DISABLE:**
 - **ENABLE:** In this case, E- STOP terminal of TB2 on EXT-TERM board should be closed in normal operation.
- **AUX INT:** Selecting auxiliary interlock: enable or disable.
 - **DISABLE:**
 - **ENABLE:** In this case, AUX-INT terminal of TB2 on EXT-TERM board should be closed in normal operation.
- **POWER CONT:** Selecting source for output power control under manual mode.
 - **LOCAL:** Output power controlled by panel knob.
 - **EXT 0-5V:** Output power controlled by Voltage level of P-DEMD terminal of TB1 on EXT-TERM board (5V=100%)
 - **EXT 4-20mA:** Output power controlled by current level of P-DEMD terminal of TB1 on EXT-TERM board (4mA=0%, 20mA=100%)
(Terminated with 250 ohm internal)
When EXT 0-5V or EXT4-20mA selected, SW2 must be set as same name on EXT-TERM board.
- **FBK MODE:** Selecting source of object control power.
 - **POWER:**
 - **CAP.V:**
 - **INV.C:**
 - **AUX 0-5V:**
 - **AUX 4-20mA:**
(When EXT 0-5V or EXT4-20mA selected, SW3 must be set as same name on EXT-TERM board.)

In this mode the operator can select which function to control on the power potentiometer, provided the load does not change. Example: Selecting POWER: when the potentiometer is set to 50% the power supply will try to deliver 50% power or 12.5kW. If selected CAP.V, 50% demand will result in 50% of 500volts or 250V. For INV.C, 50% demand will display 250A. (Given no limits are reached). If the load changes accuracy is around 15%.

5.1.3. Job select

Selecting job profile: enter PROGRAMMED mode operation. Selected job number displayed on the Program status indicator.

1. Select “JOB SELECT” in the PROGRAM menu.
2. Enter a job number(1~15) with numeric keys and press “ENT” key to select the

3. Press “ESC” key to return to PROGRAM menu without setting change.

5.1.4. Job order

Setting job parameters to operate the power supply in “PROGRAMMED” mode. The power supply can be programmed for 15 separate heating profiles or jobs. Each profile can contain up to 29 steps.

1. Select “JOB ORDER” in the PROGRAM menu.
 2. Enter a job number (1~15) with numeric keys and press “ENT” key to select the job profile. If a heating profile has previously been entered in a Job, then the values will be displayed.
 3. Enter value for each item and press “ENT” key to change and move the cursor to the next item.
 4. Use UP (▲) and DOWN (▼) key to move the cursor only without changing value.
 5. Press “SAVE” key to save all the changed values and return to “JOB ORDER” menu.
 6. Press “ESC” key to return to “JOB ORDER” menu without saving changes.
- **REPEAT:** Setting numbers of auto repeat (1~100 times)
Each Job has an auto repeat function, which enables a selected job to be repeated up to 100 times. (If 0 set, proceed as 1).
 - **PAUSE:** Pausing time must set when auto repeat times is over 1.
(Input range=0.1~6399sec. but must set 1sec. or more).
 - **STEP 1~29:** Enter the values of power level & time for each step.
 - **POWER:** (0~100 %). The power level will ramp from the last power level to the power level requested.
 - **TIME:** (0.1~6399sec).

Note: Enter “0” for the values of power level & time both at a step to stop the job process. Other steps after this step shall be ignored even they contained any values.

5.1.5. System parameters

Setting system functions

1. Select “SYSTEM” in the PROGRAM menu.
2. Enter values or select menu with numeric keys or LEFT (◀) and RIGHT (▶) key and press “ENT” key to change values and move cursor to next item.
3. Press “SAVE” key to save all the changed values and return to PROGRAM menu
4. Press “ESC” key to return to PROGRAM menu without setting change.

POWER LIMIT: Set the percentage of output power to limit level (0~100%).

100% of POWER LIMIT is 25kW, If 50% is set power output shall be limited to 12.5kW.

CAP.V LIMIT: Set the percentage of capacitor voltage to limit level (0~100%).

100% of capacitor voltage is 500V

INV.C LIMIT: Set the percentage of inverter current to limit level (0~100%).

100% of inverter current is 300A.

SHDN W/TEMP: Set the temperature of inlet water to shutdown power supply as centigrade (0~40°C). If the water temperature increase over this value, then the power supply gets a fault state and stops heating

HS TEMP: HS TEMP must be set to 50°C always.

REST W/TEMP: Set the restart-able inlet water temperature as centigrade (0~ SHDN W/TEMP). Power supply can restart after water temperature has gone down to this setting value. This value must be lower than SHDN W/TEMP value (37°C).

COMM ADDR: When the RS485 port is being used to control or monitor the power supply, a unique ID for the machine can be entered (1~255).

BAUD RATE: The communications baud rate for an RS485 connection can be set here (4.8, 9.6, 19.2, 38.4 kbps).

FREQ: Set operating frequency range. (Must be “135-400”) power supply can't work properly or can cause damage with the wrong value set.

C.RAIL: Setting configuration of capacitor rail.

Set “PARL” for parallel configuration and “SER/PARL” for series-parallel configuration. In case of this setting is C.RAIL = SER/PARL, capacitor voltage limit should be higher by 2 times; the display on LCD will be twice.

5.1.6. Start frequency

Setting start frequency (135~440 kHz).

1. Select “START FREQ” in the PROGRAM menu.
2. Enter frequency of start and press “ENT” key to save the start frequency and return to PROGRAM menu.
3. Press “ESC” key to return to PROGRAM menu without setting change.

5.1.7. Pass word

Changing password (0000~9999), Default Password is “0000”

1. Select “PASSWORD” in the PROGRAM menu.
2. Enter 4 digit password and press “ENT” key to save change and return to PROGRAM menu.
3. Press “ESC” key to return to PROGRAM menu without setting change.

5.2. Status monitoring

5.2.1. Entering a monitoring

1. Turn on the power supply.
2. Pressing the FUNC button for a second until “FUNCTION menu” sign displays on the LCD display window.
3. Select an item to monitor, use UP (▲) and DOWN (▼) keys and press “ENT” or “SEL” key to display.
4. Press “ESC” key to exit the monitoring mode.

5.2.2. Parameter status

Show status of each parameters setting “OK” or “FAIL”

- SYS: Display system parameter setting.
- CONT: Display control parameter setting.
- JOB: Display job parameter setting. If there is a “FAIL” parameter, power supply will not start heating in PROGRAMMED mode.

- CAL: display status of control board calibration. If this shows “FAIL”, it has lost the calibration data and you need to call Tech Support.

5.2.3. Inverter status

No function for this power supply.

5.2.4. Auxiliary status

- W/IN TEMP: Displays water inlet temperature as centigrade (°C).

5.2.5. Date/Time display and Setting

Display or setting date & time

To set date and time, move cursor to the item use UP (▲), DOWN (▼), LEFT (◀) and RIGHT (▶) key and enter value with numeric keys and press “ENT” key to change and move cursor to next item.

Press “SAVE” key to save changes and return to FUNCTION menu.

5.2.6. History

Display history events of Power supply.

Stores and displays the numbers of failed events that occurred in the heating process.

- TURN ON: Stores time of power on of power supply. (hour, minute)
- HEATING: Stores time of Heat on. (hour, minute)
- PRESS FAIL: Stores failure of differential pressure of cooling water.
- TEMP FAIL: Stores if exceeding temperature of cooling water.
- INV FAIL: Not activated for this power supply.
- SW/TH FAIL: Number of swing thru fail count.
- SHORT COIL: Number of resonant trips.
- INV.C TRIP: Number of inverter current trips.
- DOOR OPEN: Number of door opens.
- E-STOP: Number of emergency stops.
- AUX-INT: Number of auxiliary interlocks.

5.2.7. Version

Display firmware and PLD version of Control board and display board.

(CONT = control board, DISP = display board, S000 = firmware version, P000 = PLD version)

6. Load station tuning.

This section describes the procedures for tuning the heat station so that full power will be obtained at the desired frequency.

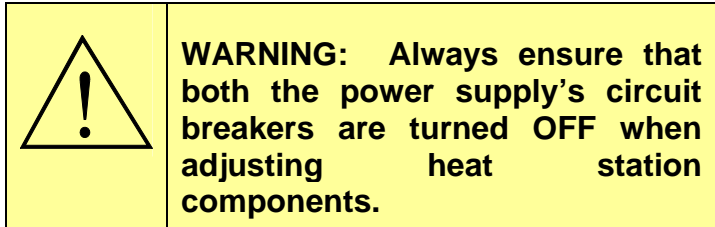

6.1 Initial setup.

The following are the steps to be taken for the initial setup of the load station for a new heating coil and/or load:

1. Install all twelve the load station capacitors.
2. Install the turns-bar in the 12 turns position and remove the two shorting bars.

Section 6.3 describes the procedures for changing heat station components.

6.2 Tuning.

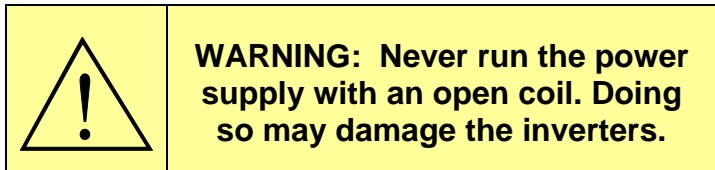

This section provides the procedures required for the tuning of the heat station for a specific heating coil and load. It is assumed that the initial setup of the heat station has been completed as described in section 6.1

The aim of this exercise is to have the unit operating at full power (25kW) at the desired frequency (user specified between 135 kHz and 400 kHz) without any indicators lit.

1. Ensure that the heat switch on the front panel is OFF state, that the program "POWER CONT=LOCAL" and that the power level knob is turned completely counter clockwise. Check that the cooling water is turned on. The unit will not deliver power if the minimum differential water pressure specification is not met, a flow trip will occur.
2. Turn on the control breaker. The green OFF indicator should light up and the LCD display should indicate that the control circuitry is powered up. Press the reset button if any trip (red) indicators are lit. Ensure the emergency stop button is not pressed in and the door is closed. Turn on the Main circuit breaker.
3. Press the ON button of the HEAT switch. Turn the POWER knob until the unit delivers approximately 10% power. If the frequency of the unit is not slightly above the desired (user specified) frequency, adjust the capacitance of the heat station and return to step 1. The required capacitance change is inversely proportional to the square of desired frequency change. Example: To increase the frequency by 40%,

the capacitance has to be halved, and vice versa. The procedure for changing the capacitors is given in section 0

4. Once the frequency is acceptable, turn the power knob to maximum power (fully clockwise).
 - If the unit is not delivering full power and the frequency is indicated as ~135 kHz (no limit indicator will be lit), the tank frequency is below the range of the unit. Decrease the capacitance and return to step 1.
 - If the limit indicator lights up and display CURR LIMIT on LCD display, increase the inductance of the series inductors, i.e. increase the turns of the inductors (move towards the back of the cabinet), until the limit indicator lights up and display FRQ LIMIT on the LCD. Next begin to decrease the inductance in small increments by moving the shorting bars up or the turn selector bar forward (away from cabinet back) to just get out of frequency limit at full power. See section 6.4.
 - If the maximum series inductance still results in a current limit, a load matching transformer is required.
 - If the frequency limit occurs, continue decreasing the inductance of the series inductors, i.e. decrease the turns of the inductors, until the FRQ LIMIT disappears on the LCD at full power. Decrease the turns in quarter turn increments by using the sliding bars, as described in section 6.4.
5. If the inductance changes of the previous step causes the frequency to go out of the acceptable range, adjust the capacitance and return to step 1.
6. Increasing the series inductances until the current reading is at minimal at full power will optimize the efficiency of the system. Highly recommended!

6.2.1. Start-frequency adjustment.

The response time of the power supply, i.e. the time from the start of the heat cycle until full power is delivered, increases as the frequency at which power is obtained decreases. If full power is obtained at 135kHz, the response time approaches half a second. This is because the power supply starts at 440kHz and then needs to decrease the frequency until power is obtained. Lowering the start frequency will decrease the response time.

Such a function is provided for applications where the operating frequency is relatively low and response times of less than half a second is required. By using this function the response time for any operating frequency can be reduced to less than 100ms. Another benefit for using the start frequency is to avoid quick current increases which can cause nuisance current trips.

See section 5.1.6. to adjust start frequency.

*Care should be taken to avoid starting the power supply below the full power operating frequency; doing so will cause a current trip.

6.3 Changing the heat station components.

This section describes the procedures for changing the heat station components.

6.3.1 Capacitors.

Apply a thin layer of thermal grease to both tabs of each capacitor and insert from the top or bottom, as indicated in Figure 4. Insert and tighten the mounting screws (four per capacitor). It is recommended that the capacitors be mounted in the positions closest to the side used for the output and no less than 4 capacitors used. Load capacitors close to each other in groups to maximize current sharing.

When using the series parallel capacitor rail configuration, add and remove capacitors in pairs, one upper and one lower, this will avoid capacitors from being damaged due to full capacitor voltage across a single capacitor.

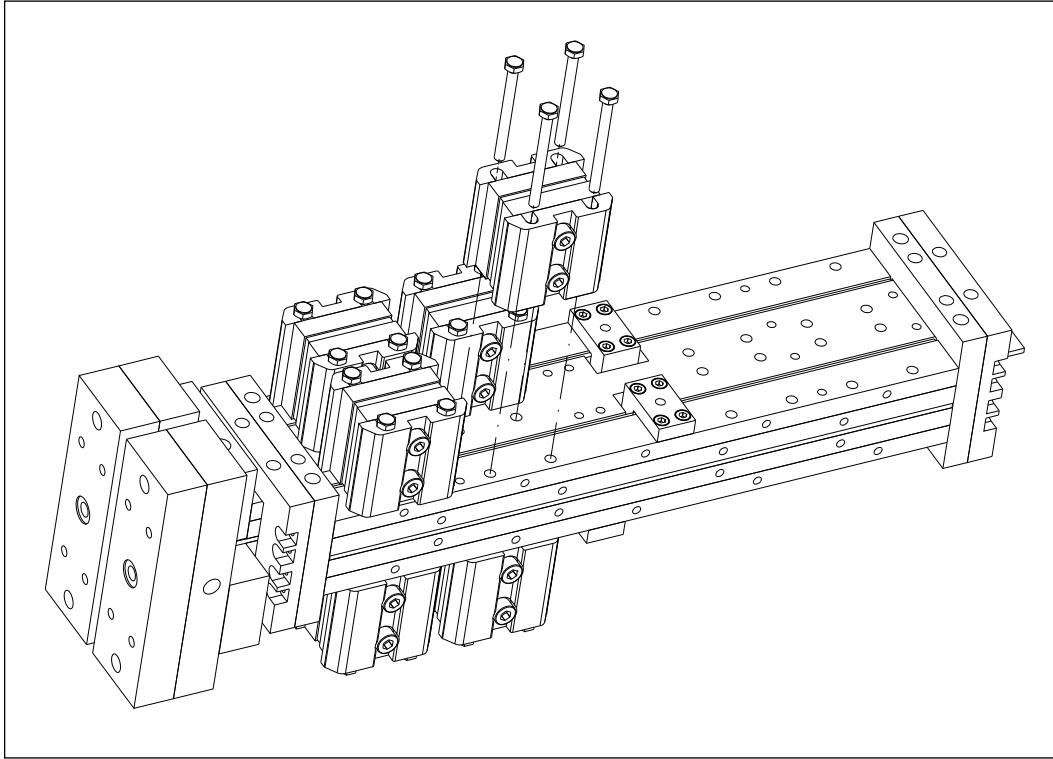

Figure 4: Changing the capacitors.

6.4 Series inductor.

The turn selector bar is identified by ① in Figure 5. For the initial setup (section 6.1) this is the only bar that is used and should be screwed onto the correct set of tabs to select the desired number of turns on the series inductor. The front position selects two turns and the back position ten turns (② in Figure 5). Tighten the bar into position using the mounting screws.

The shorting bars have to be used for finer adjustment of the series inductance during the tuning (section 6.2.) of the heat station. Table 1 indicates the positions of the turns-bar and shorting-bars for changing the turns in quarter turn steps. Move left on the table to decrease the inductance, and right to increase the inductance. Always place both the shorting-bars in the same position.

Example: If the initial setup was for ten turns (shorting bar not installed), and the turns need to be decreased with a quarter turn, install the shorting bar in the bottom (B) position (③ in Figure). Moving the shorting-bar to the middle (M) position will decrease the turns with another quarter turn, and to the top (T) position with another quarter turn. If the shorting bar reaches the top (T) position and the inductance (turns) still needs to be decreased, remove the shorting bar completely and move the turns bar forward, e.g. from the ten turns position to the nine turns position.

Table 1: Turns bar and shorting bar positions for fine tuning

Inductance	Decrease ← → Increase																
	...	6	6	6	6	7	7	7	7	8	8	8	8	9	9	9	
Turns-bar	...	6	6	6	6	7	7	7	7	8	8	8	8	9	9	9	
Shorting-bar	...	T	M	B	-	T	M	B	-	T	M	B	-	T	M	B	-

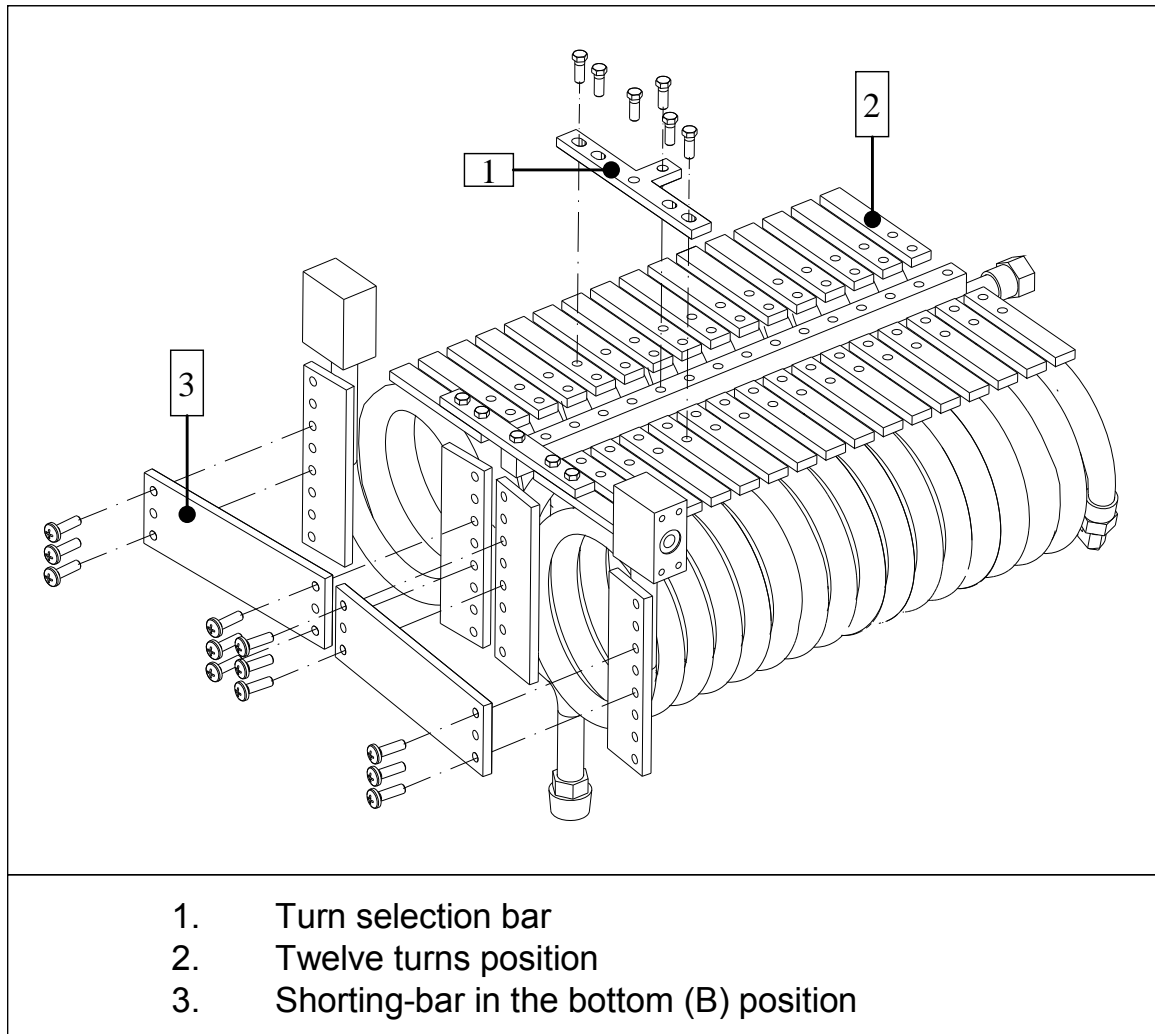
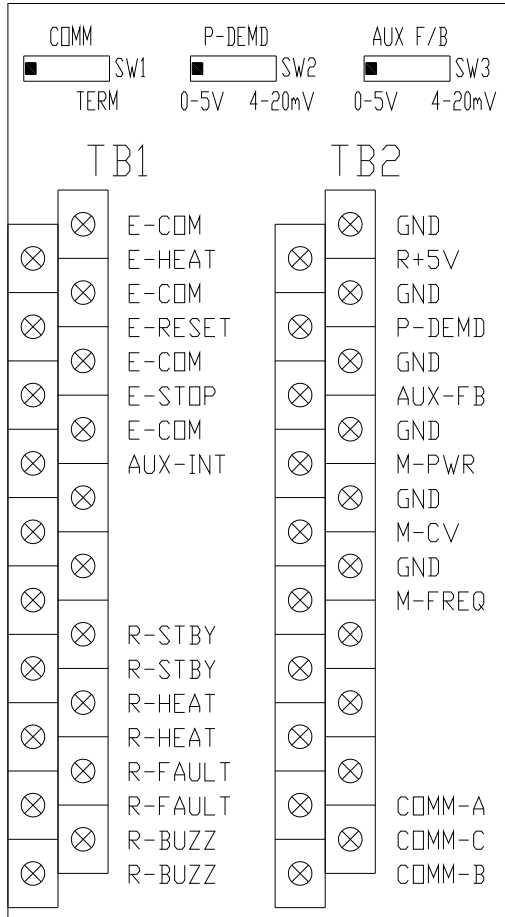

Figure 5: Adjusting the series inductor.

7. User Interface

Terminal block to connect external devices for remote control or monitoring power supply is located on the right lower inside of front door.



7.1. Terminals for external connect (TB-1)

7.1.1. Input contacts.

- E-COM; Common terminal for input contacts.
- E-HEAT; Connecting terminal E-HEAT and terminal E-COM will start the unit in the external heat control mode.
- E-RESET: Connecting terminal E-RESET and terminal E-COM will issue a fault reset if the external reset is enabled in the program.
- E-STOP: Opening a connection between terminal E-STOP and terminal E-COM will stop the heat cycle if the external e-stop is enabled in the program. This will activate the shunt trip. The front panels E-STOP switch remains in circuit.
- AUX-INT: A user defined trip can be wired between terminals AUX-IN and E-COM if the auxiliary interlock is enabled in the program.

7.1.2. Relay output contacts.

- R-STBY; Closes while power supply is in stand-by.
- R-HEAT; Closes while power supply is in heating cycle.

- R-FAULT; Closes when power supply is in a fault or tripped condition.

7.2. Terminals for I/O signals.

7.2.1. Analog signal I/O.

- GND; Common terminal for input signals (ground).
- R+5V: 5V reference: This 5V reference voltage is available for connecting to a Potentiometer remotely. Terminal R+5V to top of the pot, terminal P-DEMD to the wiper and terminal GND (ground) to the bottom of the pot.
- P-DEMD: The voltage level at this terminal controls the command reference. 0 volts is minimum, and 5 volts is maximum. A PLC can be connected to this terminal with its reference to GND. This terminal applies to the power control mode “EXT 0-5V or EXT4-20mA”, and SW2 must be set as same mode.
- AUX-FB: This terminal accepts a zero to 5 volts DC signal for a user defined feedback to the power supply. The power supply will regulate power so that a given power demand gives an equivalent amount of feedback (e.g. if the power knob is at 50%, then the power supply will bring up the power until the signal into the auxiliary feedback is at the 50% level, or 2.5V). This terminal applies to the feedback control mode “EXT 0-5V or EXT4-20mA”, and SW3 must be set a s same mode.
- M-PWR: Output power monitoring signal (0~5V, 100%=5V).
- M-CV: Output voltage monitoring signal (0~5V, 100%=5V).

7.2.2. RS-485 port.

- COMM-A; Positive signal of RS-485.
- COMM-B; Negative signal of RS-485.
- COMM-C; Ground of RS-485 connection.

REV.	DESCRIPTION	DATE	APPROVED
A	-	-	-

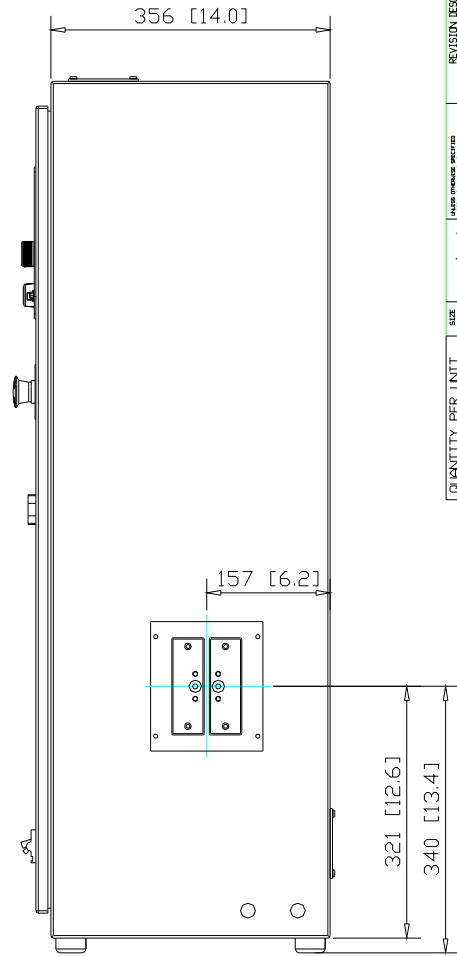
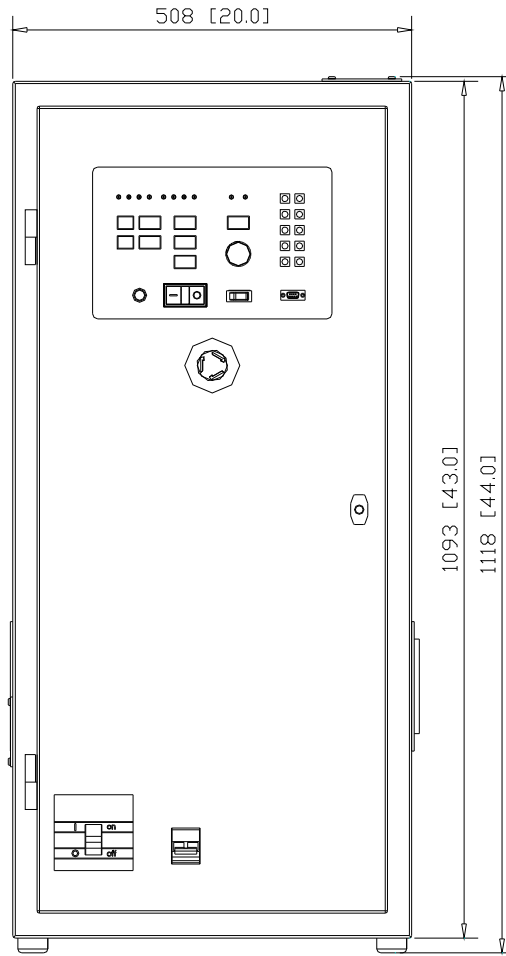
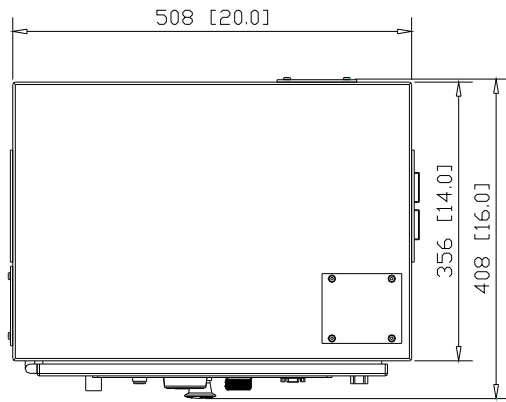

QUANTITY PER UNIT	SIZE	REV.	DESCRIPTION	REV.	DATE	REV.	DATE	REV.	DATE
	D	1	1						
	06.10.20	06.10.20	06.10.20						
	1:1								
	DO NOT SCALE DRAWING								

-		DIK CO., LTD.	
DATE	06.10.20	DATE	-
BY	YANG	BY	-

**Finding dew point using
Air Temperature and Relative Humidity in F°**

Air Temp °F	% Relative Humidity																		
	100	95	90	85	80	75	70	65	60	55	50	45	40	35	30	25	20	15	10
110	110	108	106	104	102	100	98	95	93	90	87	84	80	76	72	65	60	51	41
105	105	103	101	99	97	95	93	91	88	85	83	80	76	72	67	62	55	47	37
100	100	99	97	95	93	91	89	86	84	81	78	75	71	67	63	58	52	44	32
95	95	93	92	90	88	86	84	81	79	76	73	70	67	63	59	54	48	40	32
90	90	88	87	85	83	81	79	76	74	71	68	65	62	59	54	49	43	36	32
85	85	83	81	80	78	76	74	72	69	67	64	61	58	54	50	45	38	32	
80	80	78	77	75	73	71	69	67	65	62	59	56	53	50	45	40	35	32	
75	75	73	72	70	68	66	64	62	60	58	55	52	49	45	41	36	32		
70	70	68	67	65	63	61	59	57	55	53	50	47	44	40	37	32			
65	65	63	62	60	59	57	55	53	50	48	45	42	40	36	32				
60	60	58	57	55	53	52	50	48	45	43	41	38	35	32					
55	55	53	52	50	49	47	45	43	40	38	36	33	32						
50	50	48	46	45	44	42	40	38	36	34	32								
45	45	43	42	40	39	37	35	33	32										
40	40	39	37	35	34	32													
35	35	34	32																
32	32																		