

Induction Power Supplies

3kW; 135 – 400kHz
(Integral Heat Station)

User's Guide



Model 3-135/400-3W

Table of Contents

1. SPECIFICATIONS AND FEATURES	3
1.1. Output.....	3
1.2. Input.....	3
1.3. Physical	3
1.4. Front panel controls and indicators.....	4
1.5. Internal heat station	4
1.6. Protection.....	5
1.7. Load.....	5
2. GETTING STARTED	6
2.1. Safety Warnings	6
2.2. Set-Up	6
3. CONNECTIONS.....	7
3.1. Load.....	7
3.2. 230VAC input voltage	7
3.3. Circuit Breaker	8
3.4. Terminal Block # 1	8
3.5. Terminal Block # 2	8
4. FRONT PANEL OPERATION	9
4.1. Limit and trip indicators.....	9
4.2. Heat ON/OFF indicators.	10
4.3. Program status indicators.	10
4.4. Voltage, Current and Frequency Indicators.	10
4.5. Reset Button	10
4.6. Heat switch	10
4.7. Power Pot	10
4.8. MODE switch	11
4.9. E-Stop button.....	11
4.10. Program buttons	11
4.11. Power Display Indicator	11
4.12. Start frequency adjustment.....	11
4.13. Control selection	12
5. PROGRAMMING IN AUTO MODE.....	13
5.1. Entering a program	13
5.2. Auto Repeat Function	13
5.3. Running a program.....	14
5.4. Enabling external connections.....	14
6. LOAD STATION TUNING.....	15
6.1. Tuning.....	15
6.2. Changing the heat station components.	16
7. APPENDIX A: USER INTERFACE.....	17
7.1. Terminal Block 1	17
7.2. Terminal Block 2	17
8. APPENDIX B: TUNING EXAMPLES.....	18

1. Specifications and features

1.1. Output

Maximum Power	3kW ¹
Maximum Apparent Power	6.6kVA @ 230V input
Minimum Power Factor	0.50 @ 230 V input
Duty Cycle	100%
Maximum Voltage	350V rms ²
Frequency	135kHz to 400kHz
Maximum Response Time	0.1s ³
Minimum Allowed OFF-Time	0.5s

1.2. Input

AC line-to-line voltage	208V – 240V ± 10%, 50 to 60Hz
AC line current	14.5A @ 230V
AC power	3.6kVA

1.3. Physical

Dimensions: Length	20.5in (521mm)
Width	11.7in (297mm)
Height	12.7in (323mm)
Weight	43.5lb (20kg)

¹ 3kW is output power. 3.6kVA input power allows for losses in the power supply.

² Limited by rating of resonant capacitors.

³ When using the adjustable start-frequency feature.

1.4. Front panel controls and indicators

LED Indicators	<p>Yellow indicator for power limit.</p> <p>Yellow indicator for voltage limit.</p> <p>Yellow or red indicator (dual color) for inverter current limit or trip respectively.</p> <p>Yellow or red indicator (dual color) for frequency limit or trip respectively.</p> <p>Individual red indicators for door, temperature, flow and/or auxiliary interlock trips.</p>
Numeric Displays	<p>Run time read-outs for output voltage, inverter current and frequency</p> <p>Power Meter (0-100%)</p> <p>Job number (Auto mode)</p> <p>Step (Auto mode)</p> <p>Step Time (Auto mode)</p> <p>Elapsed time (Manual and Auto mode)</p>
Controls – Manual Mode	<p>Rocker switch for output power ON/OFF.</p> <p>Single turn knob for power level. (Manual mode)</p> <p>Pushbutton to reset trips.</p> <p>Rocker switch for manual or auto (programmed) operation.</p> <p>Emergency stop button.</p> <p>Freq button to select start frequency</p>
Controls – Programmed Mode	<p>Program, Job, Step, Freq, Pwr, Time/Freq, Clear and Enter buttons for programming automatic mode operation.</p>

1.5. Internal heat station

Resonant capacitors	Two 660nF, 350V capacitors supplied.
Series inductor	Adjustable for load matching.

1.6. Protection

Power	Limited to 3kW in any feedback configuration
Inverter output current	Limited to 70A peak. Short circuit protected.
Resonant capacitor voltage	Limited to 350V rms
Line current	32A Circuit breaker
Temperature and cooling	Air-cooling provide by three fans. Heatsink temperature switch for protection.
Safety Interlocks	Emergency stop button or door switch opens the main circuit breaker.

1.7. Load

Quality factor of load	Will operate with any load Q (including resistive loads), provided that the output frequency and voltage is within the specifications.
------------------------	--

1.8. Cooling Water

Maximum pressure	100PSI (690kPa)
Minimum differential pressure	30PSI (207kPa)
Minimum water flow	.5GPM (0.032l/s)
Trip temperature	110°F (44°C)
Minimum inlet temperature	Approx 90° (32°C) *
	*must be above dew point (see pg 19)
Minimum water resistivity	590Ω.in (1500Ω.cm)
Supply hose location	Back of Cabinet

2. Getting started

2.1. Safety Warnings

Have all operation, maintenance and servicing performed by qualified personnel only.

1. Read this operation manual completely before using the power supply.
2. **Induction heating can be dangerous.** Obey all warnings on unit and in manual.
3. **Do not touch live electrical parts.** In operation, this means the output connectors, the work coil, the work piece, and any bus work or cabling connecting them.

	<p>WARNING: These symbols, placed at the outputs of the power supply, warn of the electric shock hazard there and RF burn hazard at the outputs when the unit is operating.</p>
---	--

	<p><u>Disconnect input power before installing or servicing this unit.</u> The door interlock will open the breaker if the cover is removed. However, the input AC voltage is live at the top of the main circuit breaker.</p>
--	---

2.2. Set-Up

The following is a list of steps describing the required actions to get the power supply set up.

1. Loosen the two quarter turn fasteners and remove the cover from the unit. Check for any visual damage that could have happened during shipment. Check all plug-in connectors of PCBs.
2. Connect the heating coil to the output of the unit (see section 3.1. on page 7).
3. Read section 4. on page 9 to become familiar with the front panel controls.

	<p>WARNING: Make sure that the power is locked out before connecting AC power to the unit. Connect only 208-240VAC.</p>
---	--

4. Ensure that the circuit breaker (front of unit) on the unit is in the OFF position. Connect the power cord to a 230V single phase power source as described in section 3.2. on page 7.
5. Perform the tuning of the heat station, as described in section 6.1. on page 15.
6. The unit is now ready for operation, and can either be controlled by the front panel, or by external control. (see section 5.4 page 14)

3. Connections

This section gives a description of the required steps to connect the load, input voltage and what connections to make to run the unit remotely.

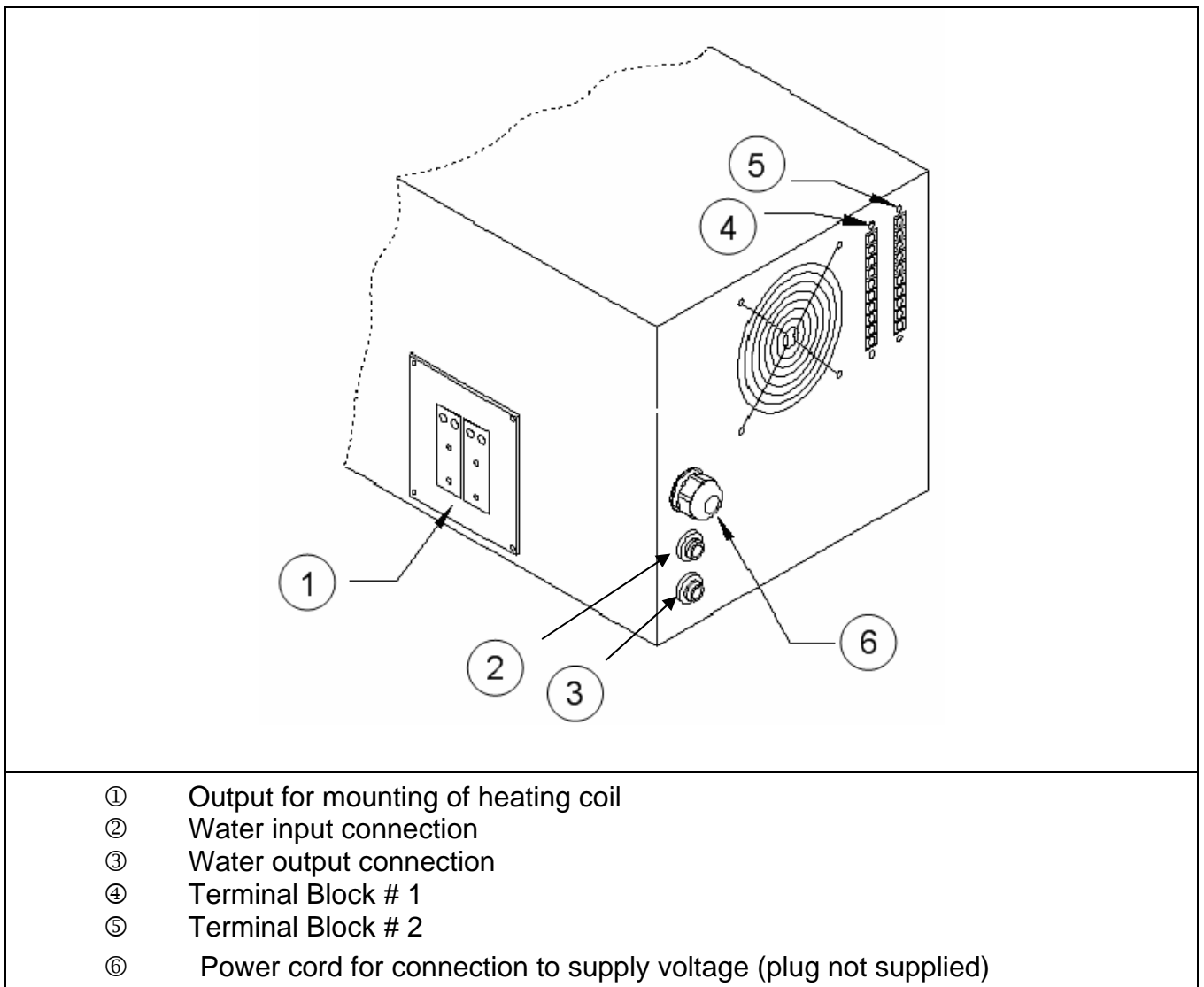

Figure 1: Terminal blocks, circuit breaker, load and input voltage connections.

3.1. Load

Mount the heating coil to the side of the unit (see ① in Figure 1) using four 10-32 non-magnetic (e.g. brass) screws. For most applications, a water cooled coil is necessary. A differential pressure switch is used in the water path, it can be defeated by shorting out Pins 4 & 5 of Terminal Block # 2. See Appendix A for more details.

3.2. 230VAC input voltage

The unit is supplied with a 6 foot long cord (see ⑥ in Figure 1). Install a single phase grounded locking plug on the power cord. Connect the plug to an appropriate supply voltage outlet socket. Note the requirements of the supply voltage given in section 1.2. on page 3. Ensure that a proper safety ground is connected to the ground terminal of the three-wire socket.

3.3. Circuit Breaker

The circuit breaker (front of cabinet) is equipped with a shunt trip which will shut off the power if the cover is removed from the unit, or if the E-Stop switch is pressed.

3.4. Terminal Block # 1

The top three terminals of Terminal Block # 1 can be utilized for remote power reference. (see ④ in Figure 1 on page 7). The lower three terminals can be used to interface the power supply with a computer. APPENDIX A: User Interface on page 17 explains the connections in more detail.

3.5. Terminal Block # 2

Heat On, E-Stop, Auxiliary Interlock, and Reset functions can be run remotely from this terminal block. There are also relay contacts for Heat On, Power Supply Fault and Power Supply ready. APPENDIX A: User Interface on page 17 explains the connections in more detail.

4. Front panel operation

This section identifies and describes the various parts of the front panel.

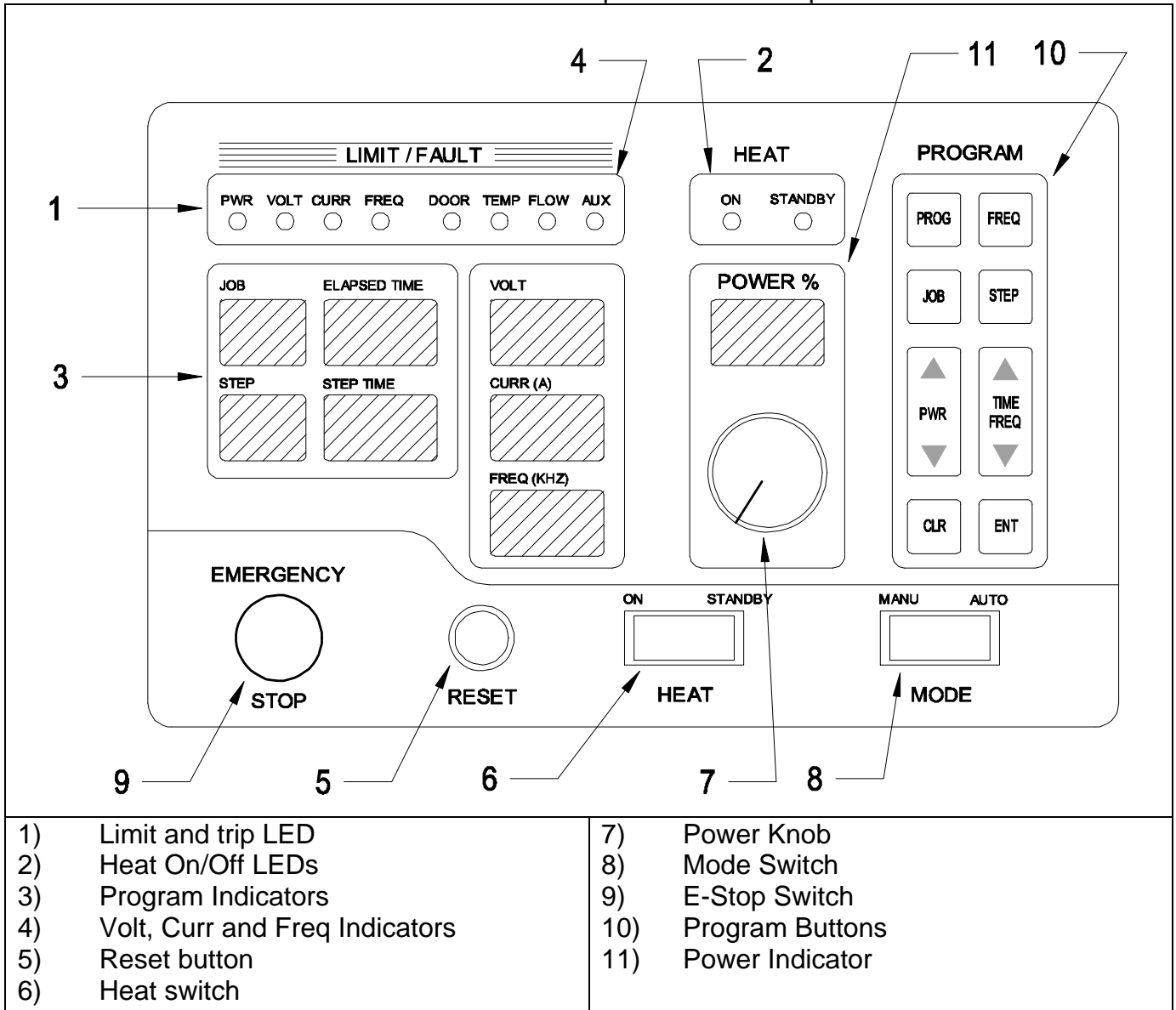

Figure 2: Front panel layout for model 3-135/400-3.

4.1. Limit and trip indicators.

Identified by 1 in **Figure 2** on page 9.

Limit indicators: These indicators are yellow in color and are lit when the heat station is not properly tuned. The power output of the unit is limited below the desired level set by the power knob or remote. There are four limit indicators:

- **POWER:** If lit the power is being limited at 3kW.
- **VOLT:** If lit the capacitor voltage is being limited at 350V rms.
- **FREQ:** If lit the circuit is being limited at the resonant frequency of the resonant tank.
- **CURRENT:** If lit the inverter current is being limited at 70A peak. (Note: The load coil current could be much higher than 70A peak).

If any limit indicators are lit, the heat station components needs to be adjusted to obtain the required power (see section 6.1. on page 15).

Trip indicators: These indicators are red in color and are lit if the unit is tripped. No power is being delivered to the load and the heat **STOP** indicator will be lit. There are six trip indicators:

- **FREQ:** The circuit momentarily operated below the resonant frequency due to a short in the load or heat station component or poor tuning of the heat station components.
- **CURRENT:** The inverter current momentarily exceeded 70A due to a short in the load or heat station component or poor tuning of the heat station components.
- **DOOR:** Indicates that the cover of the unit is not replaced.
- **TEMP:** Indicates that the temperature of the inlet water has exceeded 115°F.
- **FLOW:** Indicates water pressure is below 30 psi.
- **AUX:** An auxiliary interlock wired to the unit has tripped it, or the input AC voltage has dropped.

4.2. Heat ON/OFF indicators.

These LEDs show whether the power supply is generating output or is off. (identified by ② in Figure 2 on page 9).

4.3. Program status indicators.

Identified by ② in Figure 2 on page 9. These read-outs display the programs status when using the AUTO mode. The STEP TIME indicator display minutes and the ELAPSED TIME indicator displays seconds during manual mode operation.

4.4. Voltage, Current and Frequency Indicators.

Identified by ③ in Figure 2 on page 9. These read-outs display the output voltage, the inverter current and the operating frequency when the power supply is operating.

4.5. Reset Button

Identified by ⑤ in Figure 2 on page 9. This button is used to clear the fault indicators if a run-time or interlock trip has occurred. Depressing the button will light the limit and trip indicators and clear the latch for the fault indicator. If the LED does not go out, then the reason for the fault is still present.

4.6. Heat switch

Identified by ⑥ Figure 2 on page 9. When the power supply is energized, and no fault indicators are lit, putting this switch in the ON (I) position will start the power supply delivering heat. When moved back to the OFF (O) position, the heating will be terminated. While in AUTO mode, the ON position initiates the heat cycle. Putting the HEAT switch in the OFF position will terminate the heat cycle.

4.7. Power Pot

Identified by ⑦ in Figure 2 on page 9. The power pot sets the requested power level as indicated by the POWER read-out. The level of power output is indicated by the same POWER readout once the heat switch is on. This pot is disabled during AUTO mode operation.

4.8. MODE switch

Identified by ⑧ in Figure 2 on page 9. In the manual position, MAN, the power supply turns on with the HEAT switch and power level is controlled by the POWER POT. The programming the AUTO mode is done with the MODE switch in the MAN position. In the automatic position, AUTO, the power supply runs programmed jobs. The heat cycle is initiated with the HEAT switch and the power levels and duration of the cycle are controlled automatically, as programmed.

4.9. E-Stop button

Identified by ⑨ in Figure 2 on page 9. Pressing the E-Stop switch will stop a heat cycle and operate the shunt trip to open the circuit breaker.

4.10. Program buttons

Identified by ⑩ in Figure 2 on page 9. The program buttons are used to program and display jobs for the power supply to run automatically. See section 5. on page 13 for a description of how to program the power supply.

4.11. Power Display Indicator

Identified by ⁽¹¹⁾ in Figure 2 on page 9. This read-out displays the demand power when the unit is in standby or program mode, and displays the power output when the heat cycle is in progress.

4.12. Start frequency adjustment

The Power Supply starts at a frequency above 400kHz. To generate power it lowers the frequency until the operating frequency is near, yet still above, the resonance point of the tank circuit. If this resonant point is fairly low, below 200kHz, then it may take the power supply over one second to achieve power. A start frequency adjustment is provided to allow the user to bring the start frequency closer to the operating frequency for quicker response times.

Depress the FREQ button for 3 seconds to enable the adjustment mode, indicated by a brightening of the Frequency display. At this point, TIME/FREQ (▲) and (▼) keys can be used to adjust the start frequency. Press the enter (ENT) button and hold until the frequency lights dim. The start frequency is now set.

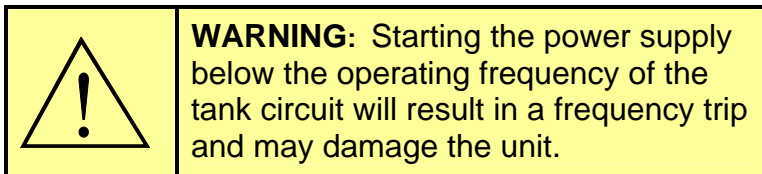

4.13. Control selection

The control used by the power supply can be selected by setting a jumper on the control PCB. The default is input power control (position J1). Output voltage (J2), auxiliary input (J3) and inverter output current (J4) can be selected.

This circuit is designed so that the operator can select which function to control on the power potentiometer, provided the load does not change. Example: Selecting power: when the potentiometer is set to 50% the power supply will try to deliver 50% power or 1.75kW. If the jumper is set to Voltage control, 50% demand will result in 50% of 350 volts or 175V. For current 50% demand will display 35A. If the load changes accuracy is around 15%.

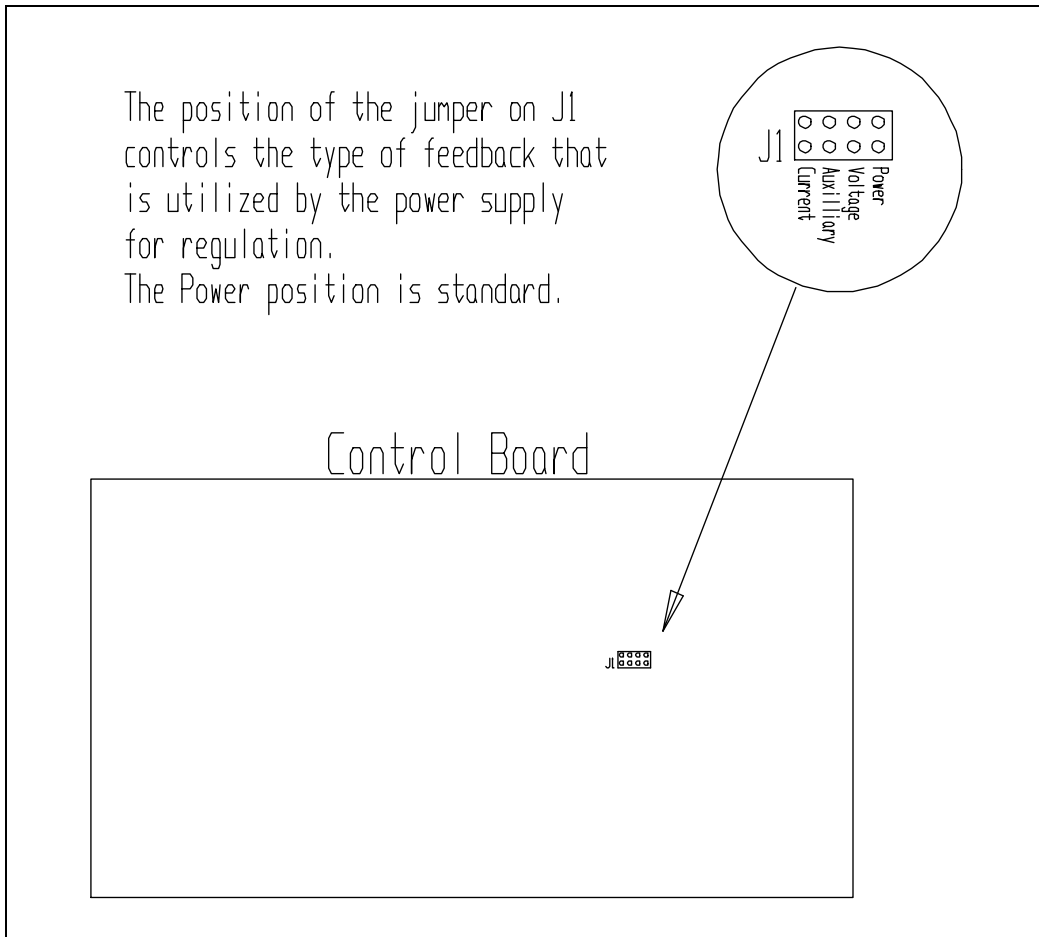

Figure 3: Control jumper location

5. Programming in AUTO mode

The power supply can be programmed 12 separate heating profiles or jobs. Each profile can contain 25 steps. The duration of each step can be up to 640 seconds.

5.1. Entering a program

1. Turn on the power supply and put the MODE selector switch in MANUAL.
2. Enter the program mode by depressing the JOB button for 2 seconds, until the Volt, Curr, and Freq displays go blank. The STEP will read 1 and JOB will display the last job used, or 1 if no other job was used.
3. If a heating profile has previously been entered in a Job, then the power and step time will be displayed on the PWR and STEP TIME readouts.
4. To clear an existing program select the job to be cleared, press the CLR button then press the ENT button twice. (once for JOB 2nd for Auto Repeat Ar)
5. A power level and a time can be entered for up to 25 steps. The power level will ramp from the last power level to the power level requested. To get a power level quickly, set the time to 0.1 seconds and then set power to the desired level. Then set the next step to that power level and the time to the desired interval.
6. For each step, press PWR UP (▲) and the PWR DOWN (▼) keys to set the power level and press TIME/FREQ UP (▲) and the TIME/FREQ DOWN (▼) keys to enter a time up to 640 seconds. For longer intervals, several steps in a row can be set to the same power level.
7. Press STEP to move to step 2. Enter power level and time as in step six.
8. Press ENT (enter) once, this will bring you to the “Ar” display (explained later), press ENT again to record changes, or press JOB to move onto the next job. Note: If no Job has been programmed an “AUX” trip indicator will be lit.
9. Pressing the CLR button will exit program mode without saving changes.

Note: Waiting too long to enter values, unit will time out and exit programming.

5.2. Auto Repeat Function

1. Each JOB (except JOB 0) has an auto repeat function, which enables a selected job to be repeated up to 999 times.
2. To activate auto repeat press and hold JOB for more than one second, after selecting the job you want to repeat press ENT once, this will open the auto repeat function.
3. In the STEP window Ar will appear, in STEP TIME and in TOTAL TIME window 0's will appear. The step time will indicate the “pause” time (indicated by a P in the STEP window) between repeat cycles and the TOTAL TIME will indicate the repeat number of cycles.
4. Press the TIME (▲) (▼) to increase or decrease the pause time.
5. Press the PWR (▲) (▼) to increase or decrease the number of repeat cycles.
6. Press ENT when completed.

Note: When using any one JOB, a time of more than .3 seconds must be entered at any STEP and a power level of more than 1% entered to avoid an “AUX” trip.

5.3. Running a program

1. With the MODE selector in manual, press JOB to enter program mode. Press the JOB key to select the job you wish to run. Press enter (ENT).
2. To view the job parameters before running the job, press the STEP button will display the power and time for each step.
3. Put the MODE selector switch in the AUTO position.
4. Put the HEAT switch in the ON position to run the selected job.

5.4. Enabling external connections.

The external connections on Terminal Block # 2 can be enabled from the front panel controls. Pressing the PROG button for 2 seconds will enter the parameter setting mode. The step button can be used to cycle through the parameters, and the TIME/FREQ UP and DOWN buttons can be used to change them. For these parameters, EN means Enable and DIS means Disable.

E-H External Heat: **Disable**- The external heat control is not available and only controlled from the front panel. **Enable** -The heat cycle is started by connecting terminal 1 and 5 on Terminal Block # 2.

E-S External Emergency Stop: **Disable** -The terminal block connection for E-Stop is ignored. **Enable** - terminals 2 & 5 must be connected for the power supply to operate. When opened, the heat cycle is terminated, but the circuit breaker will not be opened by the shunt trip as it would by pressing the E-Stop button.

E-A External Auxiliary Trip: **Disable** - The terminal block connection for Auxiliary Trip is ignored. **Enable** - When terminals 3 & 5 are not connected, an Auxiliary Trip will display on the front panel, and the unit will not operate.

Note that the RESET function, terminal 4 & 5 is always enabled. There is no soft switch for this function.

ADR Address: When the RS485 port is being used to control or monitor the power supply, a unique ID for the machine can be entered (00-99).

BR Baud Rate: The communications baud rate for an RS485 connection can be set here (2.4, 4.8, 9.6, 19.2, 38.4 kbps).

6. Load station tuning.

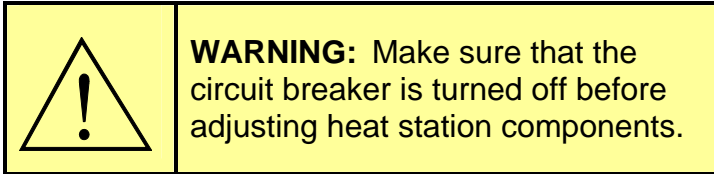

This section describes the procedures for tuning the heat station so that full power will be obtained at the desired frequency.

6.1. Tuning.

This section provides the procedures required for the final tuning of the heat station for a specific heating coil and load. It is assumed that the initial setup of the heat station has been completed as described in section 3.

The aim of this exercise is to have the unit operating at full power of 3kW without any indicators lit.

1. Ensure that the heat switch on the front panel is in the OFF position, that the MODE selection switch is in the MAN (manual) position and that the power level knob is turned fully counter-clockwise (see Figure 2 on page 9). Turn on the circuit breaker. The green STOP indicator should light up, indicating that the unit is powered up. Press the reset button if any red trip indicators are lit.
2. Put the HEAT switch in the ON position.
 - If the unit is not delivering full power and the frequency is indicated as ~135kHz (no limit indicators will be lit), the tank frequency is outside the range of the unit.
 - If the current limit indicator lights up or a current trip occurs, continue increasing the inductance of the series inductor, i.e. increase the turns of the inductor, until the current limit indicator stops to light up at full power. Increase the turns using the turn selector bar, as described in section 6.2.1 on page 16. .
 - If the frequency limit indicator lights up or a frequency trip occurs, continue decreasing the inductance of the series inductor, i.e. decrease the turns of the inductor, until the frequency limit indicator stops to light up at full power. Decrease the turns in small increments by using the shorting bar, as described in 6.2.1 on page 16.
3. Increasing the series inductance until the current reading is around 50% at full power will optimize the efficiency of the system. This will act to protect the transformer and capacitors from overheating. Highly recommended!

6.2. Changing the heat station components.

This section describes the procedures for changing the heat station components.

6.2.1. Series inductor.

The turn selector bar is identified by ① in Figure 4 on page 16. The near position selects zero turns and the far position eleven turns, as indicated in Figure 4 on page 16. Tighten the bar into position using the mounting screws.

The shorting bar has to be used for finer adjustment of the series inductance during the tuning (section 6.1. on page 15) of the heat station.

Example: If the initial setup was for 4 turns (shorting bar not installed), and the turns needs to be decreased with a quarter turn, install the shorting bar in the low (3) position. If the shorting bar reaches the high (1) position and the inductance still needs to be decreased, remove the shorting bar completely and move the turns bar one position forward, e.g. from the 4 turns position to the 3 turns position.

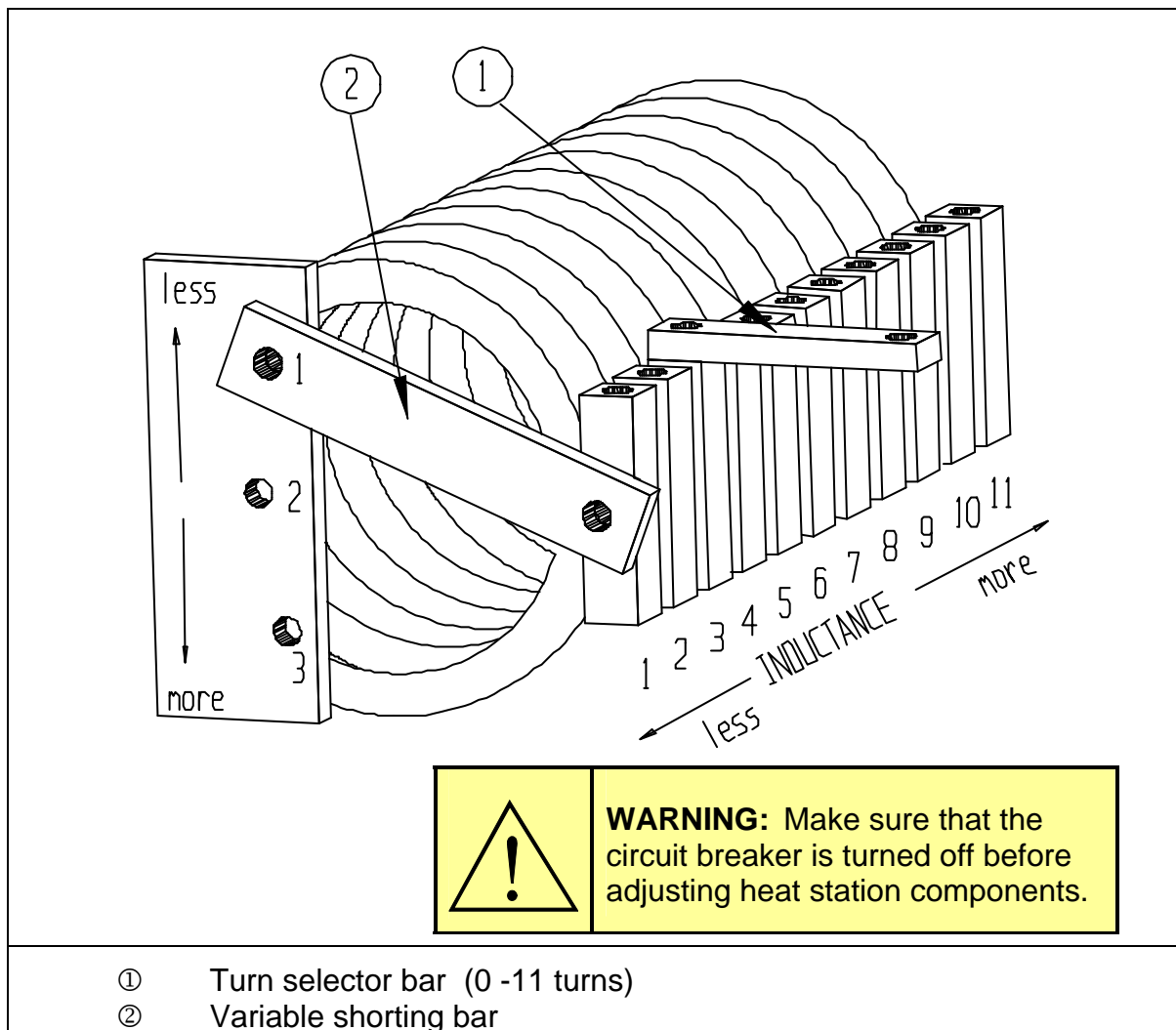

Figure 4: Adjusting the Series Inductor

7. APPENDIX A: User Interface

7.1. Terminal Block 1

- 1) 10V reference: This 10V reference voltage is available for connecting to a potentiometer remotely. Terminal 1 to top of the pot, terminal 2 to the wiper and terminal 3 (ground) to the bottom of the pot.
- 2) Remote Power Reference: When SW1 (on display brd), the INT/EXT switch is set to EXT, the voltage level at this terminal controls the command reference. 0 volts is minimum, and 10 volts is maximum. A PLC can be connected to terminal 2 with its reference to terminal 3.
- 3) Reference Ground: Used with terminals 1 & 2, the ground for the power reference.
- 4) AFBK Auxiliary Feed Back not currently active.
- 5) Common for AFBK.
- 6) Flow: by shorting to common can be used to disable internal pressure switch.
- 7) Common for Flow.
- 8-10) This is an RS485 Port. It is configured to be asynchronous, half duplex with an 8 bit, 1 stop bit format. This is a dedicated protocol. The baud rate is selectable to from 2400 baud to 38400 baud.
- 8) Terminal A of the RS-485 port.
- 9) Terminal B of the RS-485 port.
- 10) Common for the RS 485 port.

7.2. Terminal Block 2

See section 5.4. on page 14 for more information on enabling these connections.

- 1) START/STOP: Connecting terminal 1 to terminal 5 will start the unit. This is enabled when E-H is set to EN.
- 2) E-STOP: Opening a connection between terminal 2 and terminal 5 will stop the heat cycle. This is enabled when E-S is set to EN. This will not activate the shunt trip. The front panel E-STOP switch remains in circuit.
- 3) AUX: A user defined trip can be wired between terminals 3 and 5. Enabled when E-A is set to EN.
- 4) RESET: Connecting terminal 4 to terminal 5 will issue a fault reset. This is always be enabled.
- 5) COMMON
- 6) Not used
- 7-10) 7, 8, & 9 are normally open relay connections with 10 being common for all relays.
- 7) HEAT ON: Connected to COM when HEAT cycle is on.
- 8) FAULT: Connected to COM when a FAULT occurs
- 9) READY: Connected to COM when the HEAT cycle is off and no faults exist.
- 10) COM: Common connection for the relays

The contacts for these relays are rated at 250V, 3A.

8. APPENDIX B: Tuning examples

The following examples are intended as a guideline for tuning the power supply only. It is recommended that users add examples of their applications to this list as a reference future applications.

Load	Caps (uf)	Taps	Coil (# turns x I.D.)	Freq (kHz)	Power (kW)	Voltage (Vrms)	Inverter Current	Notes
1" steel pipe	1.320	8	4 x 2.5"	165	3	180	74	
1" steel pipe	1.320	7	2 x 2.5"	223	3	160	54	
1" steel pipe	1.320	5	1 x 2.5"	349	2.9	183	70	
Open	1.320	8	5 x 3/4"	308	3	230	44	
1" steel pipe	1.320	3	3 x 1.5"	324	3	90	70	
1" steel pipe	0.660	5	3 x 1.5"	392	1.2	70	24	Frequency limit
1" steel pipe	0.210	10	8 x 4"	256	2.3	500	65	Capacitor limit
.2" x 1/2" stud	1.320	5	3 x 3/4"	300	3	230	70	
1" brass pipe	0.66	8	4X2"	258	2	350	67	Capacitor limit
1" brass pipe	1.320	10	4X2"	176	3	327	66	
1" galvanized pipe	1.320	6	4X2"	275	3	133	52	
1" galvanized	.660	5	4X2"	275	3	171	57	
3/4" steel	1.320	4	3X1 1/4"	292	2.8	115	65	
3/4" galvanized	1.320	5	1X1 1/2"	360	3	204	58	
1/2" steel stud	1.98	3	2X 5/8"	315	2	80	69	

Find DEW
Air

point using

Air Temp °F	% Relative Humidity																		
	100	95	90	85	80	75	70	65	60	55	50	45	40	35	30	25	20	15	10
110	110	108	106	104	102	100	98	95	93	90	87	84	80	76	72	65	60	51	41
105	105	103	101	99	97	95	93	91	88	85	83	80	76	72	67	62	55	47	37
100	100	99	97	95	93	91	89	86	84	81	78	75	71	67	63	58	52	44	32
95	95	93	92	90	88	86	84	81	79	76	73	70	67	63	59	54	48	40	32
90	90	88	87	85	83	81	79	76	74	71	68	65	62	59	54	49	43	36	32
85	85	83	81	80	78	76	74	72	69	67	64	61	58	54	50	45	38	32	
80	80	78	77	75	73	71	69	67	65	62	59	56	53	50	45	40	35	32	
75	75	73	72	70	68	66	64	62	60	58	55	52	49	45	41	36	32		
70	70	68	67	65	63	61	59	57	55	53	50	47	44	40	37	32			
65	65	63	62	60	59	57	55	53	50	48	45	42	40	36	32				
60	60	58	57	55	53	52	50	48	45	43	41	38	35	32					
55	55	53	52	50	49	47	45	43	40	38	36	33	32						
50	50	48	46	45	44	42	40	38	36	34	32								
45	45	43	42	40	39	37	35	33	32										
40	40	39	37	35	34	32													
35	35	34	32																
32	32																		

Temperature and Relative Humidity in F°

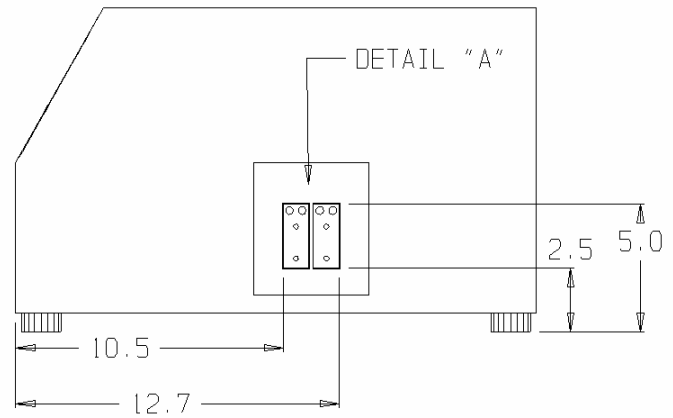
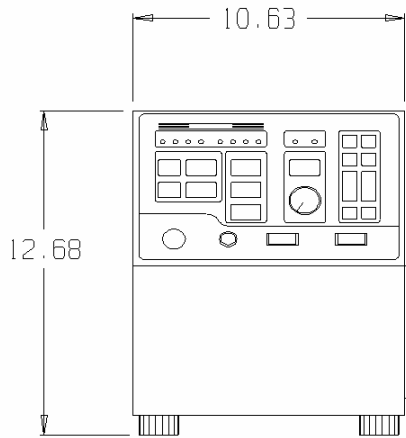
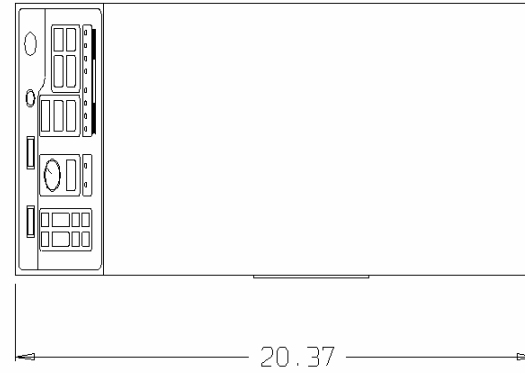
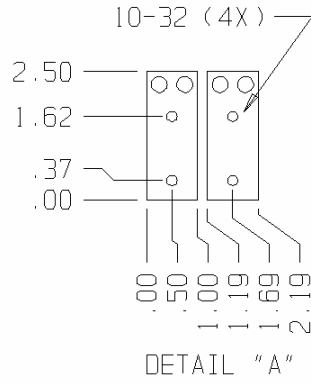
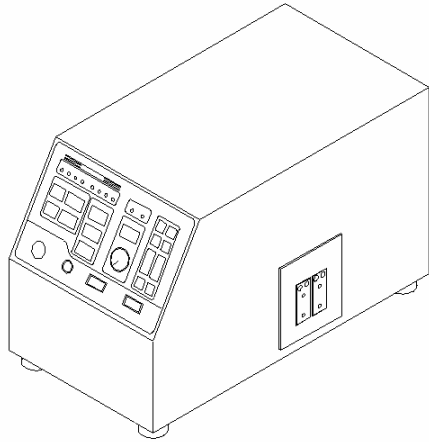

QUANTITY PER UNIT 1	SIZE D	SHEET 1 OF 1	UNLESS OTHERWISE SPECIFIED DIMENSIONS ARE IN INCHES FRACTIONS DECIMALS ANGLES	POSITION DESCRIPTION			CABINET OUTLINE	DRAWN BY: DS & RL	DATE: 09/24/04	ENG. NO. 11100500
	DESCRIPTION		REV. BY	REV. DATE	REV. NO.	3kW UNIT				
SCALE: DO NOT SCALE DRAWING			TITAN							

